



深圳市弗瑞鑫电子有限公司

规格承认书

—

prepare	
check	
approve	



TRX电容一级代理商
深圳市弗瑞鑫电子有限公司

Add: 深圳市宝安区西乡大道302号金源商务大厦B座3楼

Tel: 0755-29563634

Fax: 0755-27447020

SMD 2

SMD 2 . .

/N

/D

/E

/P

	SMD 2 SMD 2 . .		
	/N		/D
	/E		/P

 TRX 专注电容器廿年	SMD 2		
	SMD 2 . .		
	/N		/D
/E		/P	

1. /P N

T B 2 102 M E
 ① ② ③ ④ ⑤ ⑥

①		
②		
③		
④		
⑤		
⑥		

2. /P

	 TRX TL E 102M X1 440V~
--	---

	SMD 2		
	SMD 2 . .		
	/N		/D
	/E		/P

3. /D



 TRX 专注电容器廿年	SMD 2 SMD 2 . .		
	/N		/D
	/E		/P

4. /C

5. /P

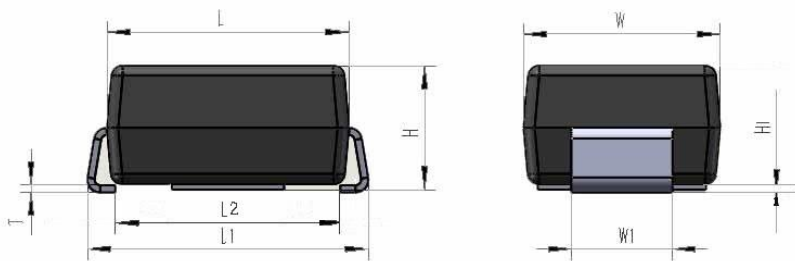

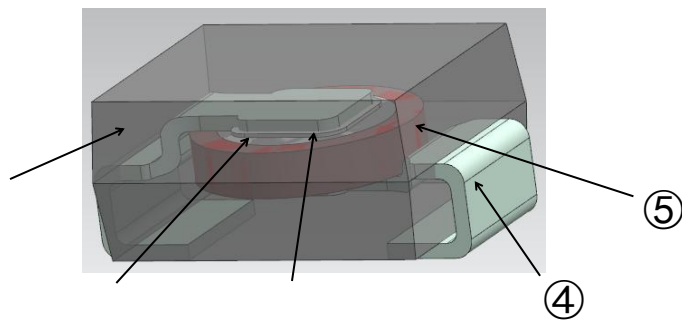

①		
②		
③		
④		
⑤		

 TRX 专注电容器廿年	SMD 2 SMD 2 . .		
	/N		/D
	/E		/P

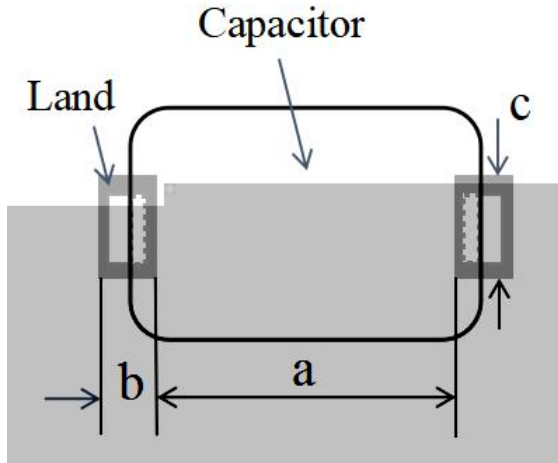

6. /S
/

°
°C
°
°
°

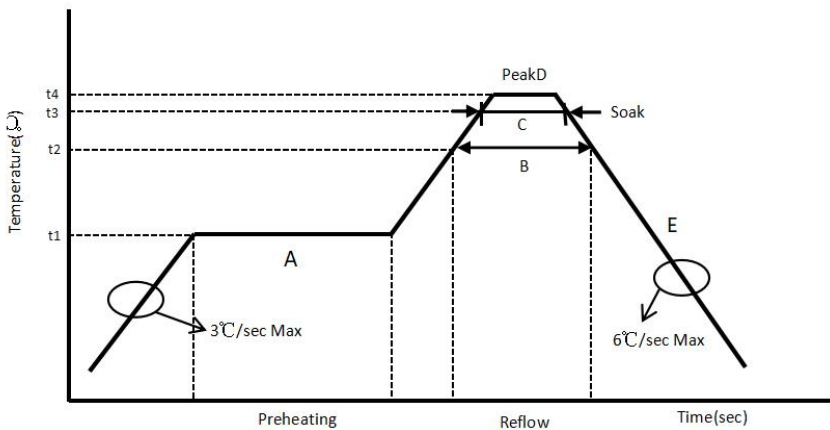

 TRX 专注电容器廿年	SMD 2 SMD 2 . .		
	/N		/D
	/E		/P

/

°
°C

°

°

°

/

7. /P



SMD 2

SMD 2 . .

/N

/D

/E

/P

△



TRX

专注电容器廿年

SMD 2

SMD 2 . .

/N

/D

/E

/P



SMD 2
SMD 2 . .

/N

/D

/E

/P

			△ △ △ △ △
			△ △ △ △ △

 TRX 专注电容器廿年	SMD 2		
	SMD 2 . .		
	/N		/D
	/E		/P

8. /C

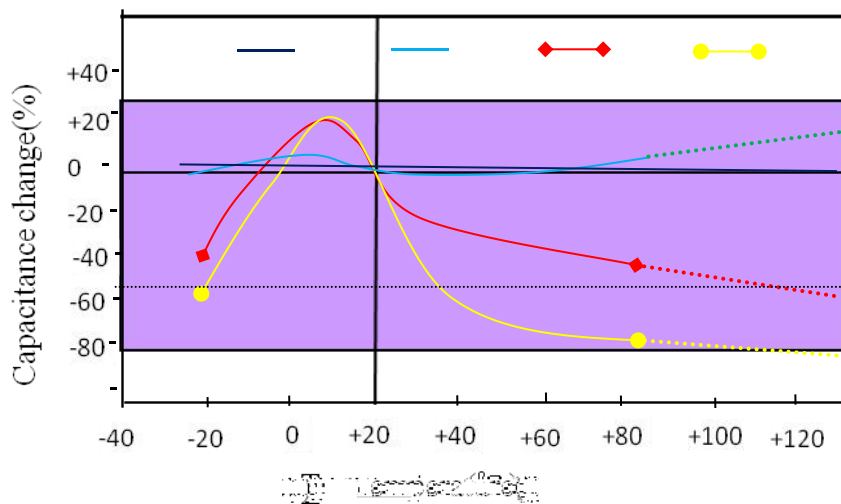

 TRX 专注电容器廿年	SMD 2		
	SMD 2 . .		
	/N		/D
/E		/P	

9. /C

**R HS H.F.
REACH**

10. /S

(1)

(2)

(3)

(4)

/
/

 TRX 专注电容器廿年	SMD 2		
	SMD 2 . .		
	/N		/D
	/E		/P

11. /P P
/

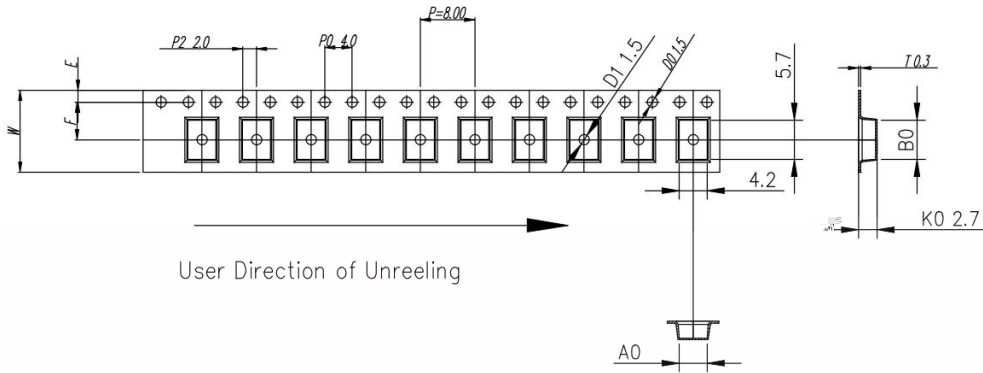

ITEM	W	A0	B0	K1	K0	P	F	E	D0	D1	P0	P2	T
DIM	12.0	4.7 ± 0.30	5.70 ± 0.10	--	2.70 ± 0.10	8.00 ± 0.10	5.50 ± 0.10	1.75 ± 0.10	$\phi 1.5 \pm 0.10$	$\phi 1.5 \pm 0.10$	4.0 ± 0.10	2.0 ± 0.10	0.30 ± 0.05
ALTERNATE													

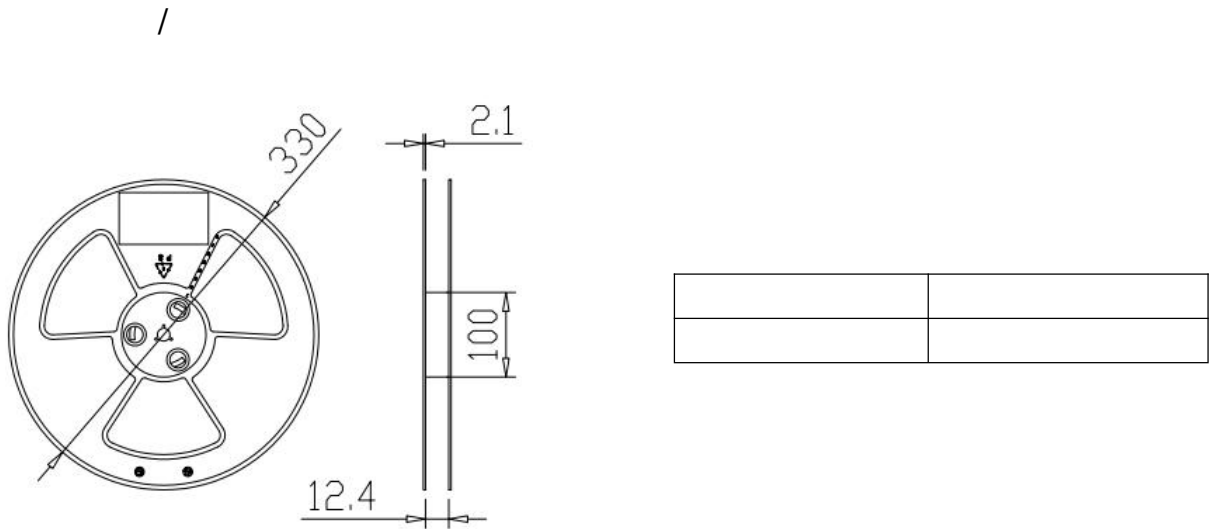

Item	Data	Remark
Cover tape adhesion	10 ~ 100g	Carrier tape and cover tape open angle 165 ~ 180° F=300±5mm/minute

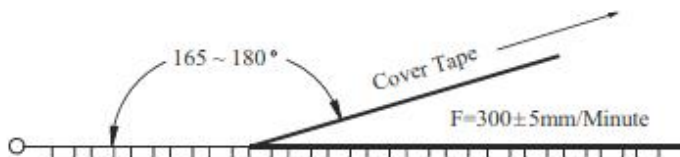

 TRX 专注电容器廿年	SMD 2 SMD 2 . .		
	/N		/D
	/E		/P

/ -

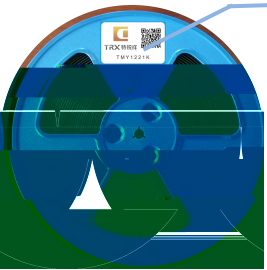

标签



料号

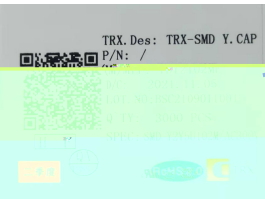



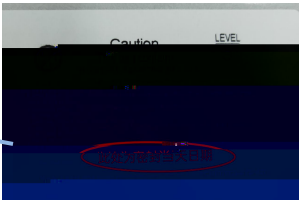

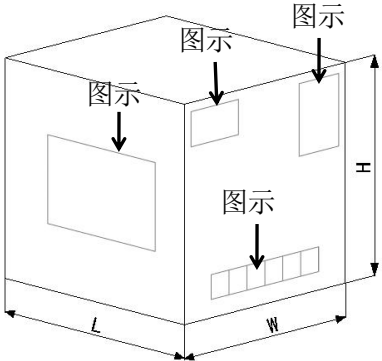

/O -







图示 / 图示 / 图示 /



/P :









R

	SMD 2		
	SMD 2 . .		
	/N		/D
/E		/P	

12. /A

①

②