



# 深圳市弗瑞鑫电子有限公司

## 规格承认书

—

\_\_\_\_\_

\_\_\_\_\_

prepare	
check	
approve	



TRX电容一级代理商  
深圳市弗瑞鑫电子有限公司

Add: 深圳市宝安区西乡大道302号金源商务大厦B座3楼

Tel: 0755-29563634

Fax: 0755-27447020

- 2

2 . .

/

/

/

/

	- 2 2 . .		
	/		/
	/		/

	- 2 2 . .		
	/		/
	/		/

1. /

$\overline{\text{①}}$   $\overline{\text{②}}$   $\overline{\text{③}}$   $\overline{\text{④}}$   $\overline{\text{⑤}}$   $\overline{\text{⑥}}$

①

	- 2 2 . .		
	/		/
	/		/

3. /



4. /

5. /





①		
②		
③		
④		
⑤		

- 2  
2 ..

/

/

/

2

	- 2 2 . .		
	/		/
	/		/

/

°  
°C

°

°

°

/

7. /



	- 2 2 . .		
	/		/
	/		/





- 2  
2 ..

/

/

/

/

					±
		±			
		±			
		±			
		±			



**TRX**  
 专注电容器廿年

- 2  
 2 . .

/

/

/

/

			±
			△ △ △ △ △
			△ △ △ △ △



			$\pm$ $\pm$ $\pm$ $\pm$ $\pm$
			$\pm$ $\pm$ $\pm$ $\pm$ $\pm$

8. /

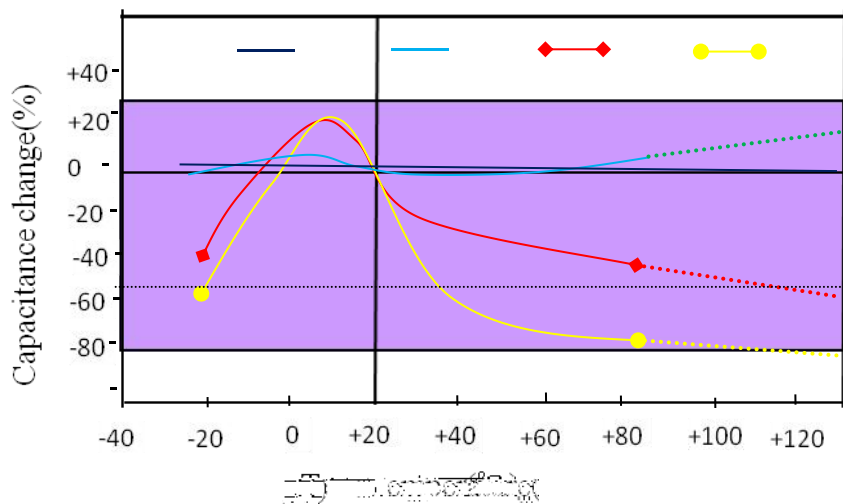

 <b>TRX</b> 专注电容器廿年	- 2 2 . .		
	/		/
	/		/

9. /







10. /

(1)

(2)

/  
/  
(3)

(4)

×

11. /  
/

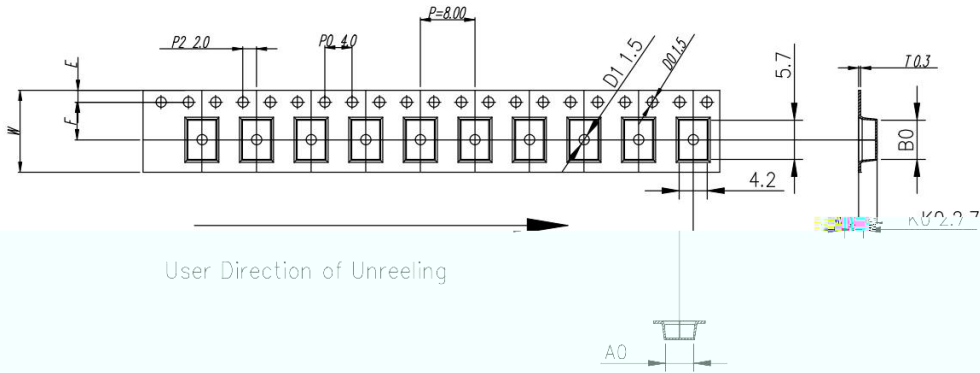

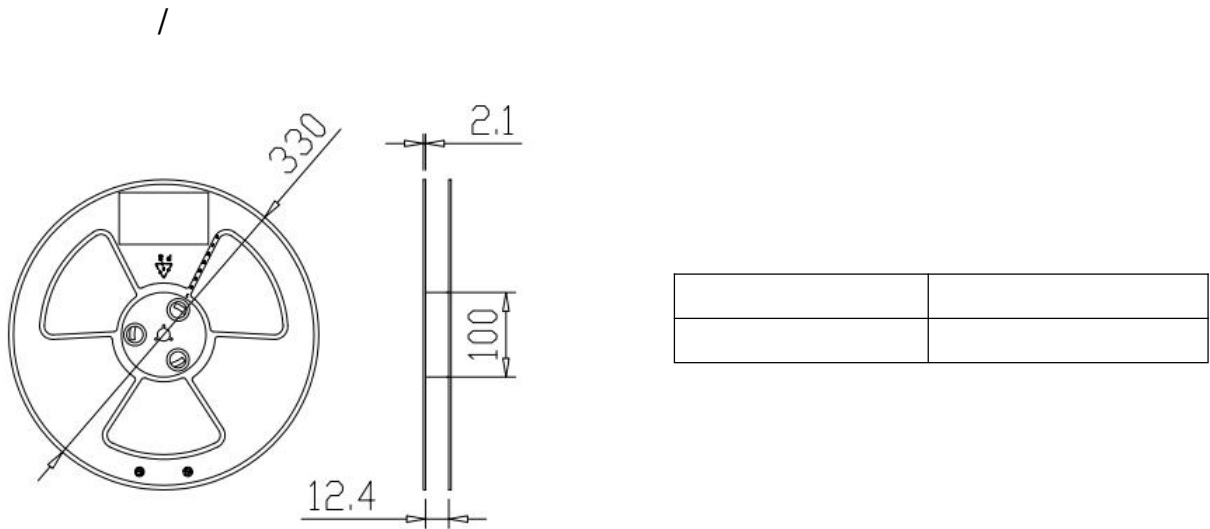

ITEM	W	A0	B0	K1	K0	P	F	E	D0	D1	P0	P2	T
DIM	12.0	$4.20^{+0.30/-0.30}$	$5.70^{+0.10/-0.10}$	--	$2.70^{+0.10/-0.10}$	8.00	$5.50^{+0.10/-0.10}$	1.75	$\phi 1.5^{+0.10/-0.00}$	$\phi 1.5^{+0.10/-0.10}$	4.00	2.0	0.30
ALTERNATE													

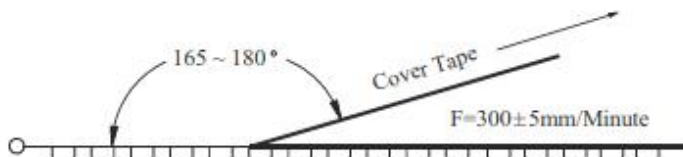

/

Item	Data	Remark
Cover tape adhesion	10 ~ 100g	Carrier tape and cover tape open angle 165 ~ 180° F=300±5mm/minute

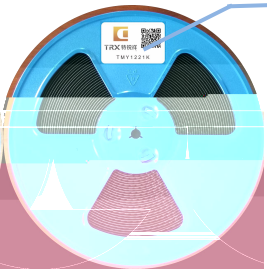

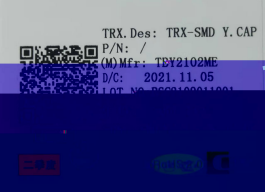
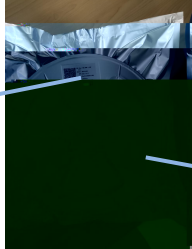
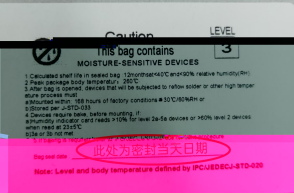
/ -	 <p>标签</p>  <p>料号</p>   		
-----	--	--	--

/ -	   	<p>图示 /                      图示 /                      图示 /</p> <table border="1" style="width: 100%; height: 60px;"> <tr> <td></td> <td></td> <td></td> <td></td> </tr> <tr> <td></td> <td></td> <td></td> <td></td> </tr> </table>								

/ :	   
-----	--

" "



	- 2 2 . .		
	/		/
	/		/

12. / 

①

②