



深圳市弗瑞鑫电子有限公司

规格承认书

—

prepare	
check	
approve	



TRX电容一级代理商
深圳市弗瑞鑫电子有限公司

Add: 深圳市宝安区西乡大道302号金源商务大厦B座3楼

Tel: 0755-29563634

Fax: 0755-27447020

	- 2 2 . .		
	/		/
	/		/

	- 2 2 . .		
	/		/
	/		/

1. /

$\overline{\text{①}}$ $\overline{\text{②}}$ $\overline{\text{③}}$ $\overline{\text{④}}$ $\overline{\text{⑤}}$ $\overline{\text{⑥}}$

①

	- 2 2 . .		
	/		/
	/		/

3. /



4. /

5. /





①		
②		
③		
④		
⑤		

- 2
2 ..

/

/

/

	- 2 2 . .		
	/		/
	/		/

/

°
°C

°

°

°

/

7. /

	- 2 2 . .		
	/		/
	/		/





- 2
2 ..

/

/

/

/

					±
		±			
		±			
		±			
		±			

			± ±
			± ± ±
			± ± ±

8. /

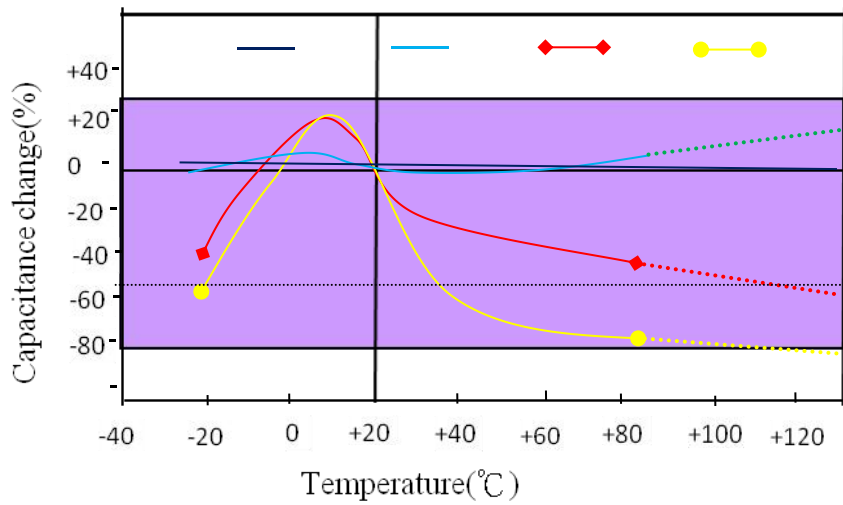

 TRX 专注电容器廿年	- 2 2 . .		
	/		/
	/		/

9. /



10. /
(1)

(2)

/
/
(3)

(4)
x

11. /
/

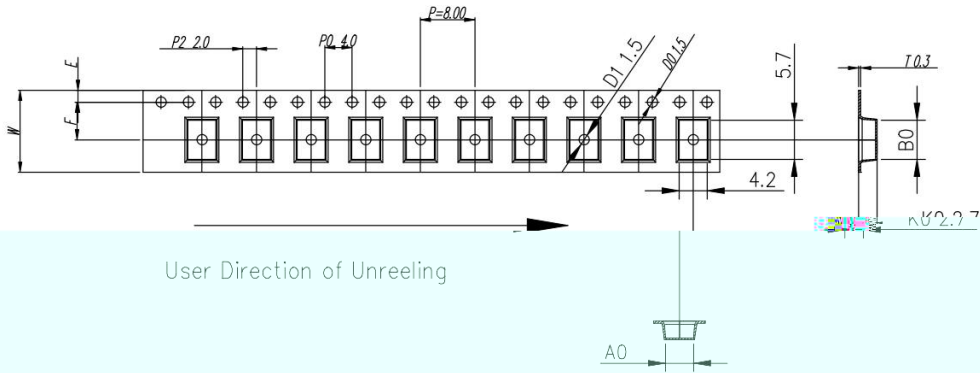



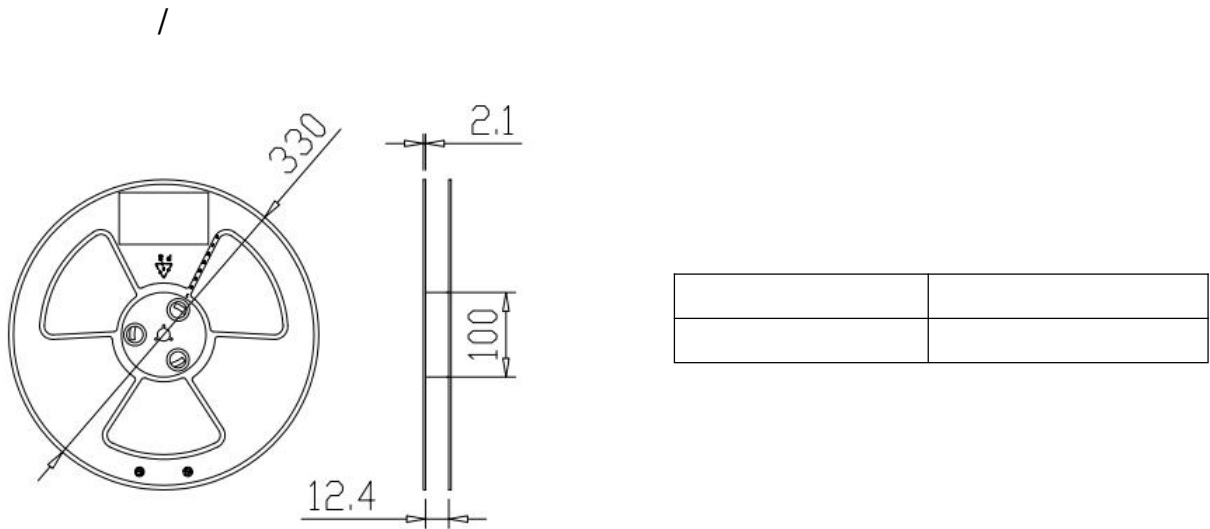

ITEM	W	A0	B0	K1	K0	P	F	E	D0	D1	P0	P2	T
DIM	12.0 ±0.30	4.7 ±0.10	5.70 ±0.10	--	2.70 ±0.10	8.00 ±0.10	5.50 ±0.10	1.75 ±0.10	∅ 1.5 ±0.05	∅ 1.5 ±0.10	4.0 ±0.10	2.0 ±0.10	0.30 ±0.05
ALTERNATE													



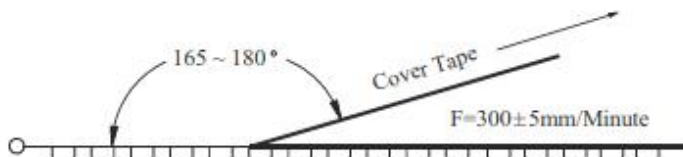

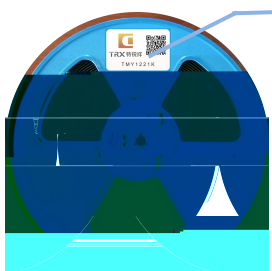
/

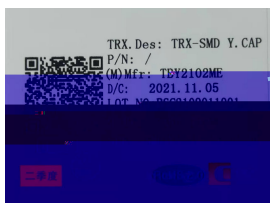
Item	Data	Remark
Cover tape adhesion	10 ~ 100g	Carrier tape and cover tape open angle 165 ~ 180° F=300±5mm/minute

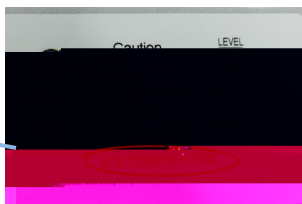

/ -	 <p style="margin-left: 10px;">标签</p>  <p style="margin-left: 10px;">料号</p>	
	  	

/ -		  										
	图示 / 图示 / 图示 /											
		<table border="1" style="width: 100%; border-collapse: collapse;"> <tr> <td colspan="5"></td> </tr> <tr> <td></td> <td></td> <td></td> <td></td> <td></td> </tr> </table>										

/ :				
	/	/		

" "

	- 2 2 . .		
	/		/
	/		/

12. /

①

②