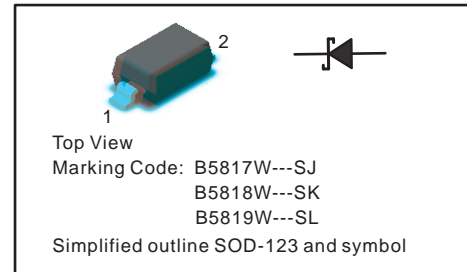

**SCHOTTKY BARRIER RECTIFIERS**
**FEATURES**

- Metal silicon junction, majority carrier conduction
- Guarding for overvoltage protection
- Low power loss, high efficiency
- High current capability
- low forward voltage drop
- High surge capability
- For use in low voltage, high frequency inverters, free wheeling, and polarity protection applications

**PINNING**

PIN	DESCRIPTION
1	Cathode
2	Anode

**MECHANICAL DATA**

- Case: SOD-123
- Terminals: Solderable per MIL-STD-750, Method 2026
- Approx. Weight: 16mg 0.00056oz

**Maximum Ratings and Electrical characteristics**

Ratings at 25 °C ambient temperature unless otherwise specified.

Parameter	Symbols	B5817W	B5818W	B5819W	Units
Maximum Repetitive Peak Reverse Voltage	$V_{RRM}$	20	30	40	V
Maximum RMS voltage	$V_{RMS}$	14	21	28	V
Maximum DC Blocking Voltage	$V_{DC}$	20	30	40	V
Maximum Average Forward Rectified Current	$I_{F(AV)}$	1			A
Peak Forward Surge Current, 8.3ms Single Half Sine-wave Superimposed On Rated Load (JEDEC method)	$I_{FSM}$	9			A
Maximum Instantaneous Forward Voltage at 1 A at 3 A	$V_F$	0.45 0.75	0.55 0.875	0.6 0.9	V
Maximum Instantaneous Reverse Current at $T_A = 25^\circ\text{C}$ Rated DC Reverse Voltage $T_A = 100^\circ\text{C}$	$I_R$	1 10			mA
Typical Junction Capacitance	$C_j$	110			pF
Storage and Operating Junction Temperature Range	$T_j, T_{stg}$	-55 ~ +125			°C

**Fig.2 Typical Reverse Characteristics**

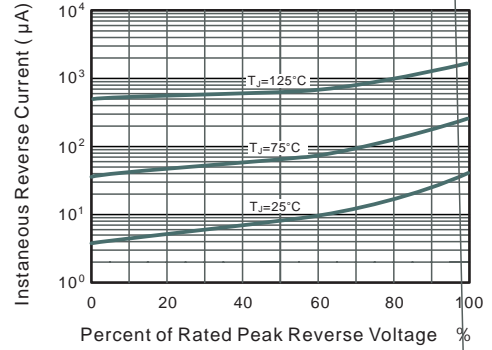

**Fig.3 Typical Forward Characteristic**

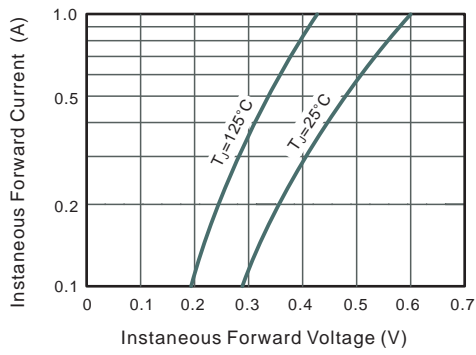

**Fig.4 Typical Junction Capacitance**

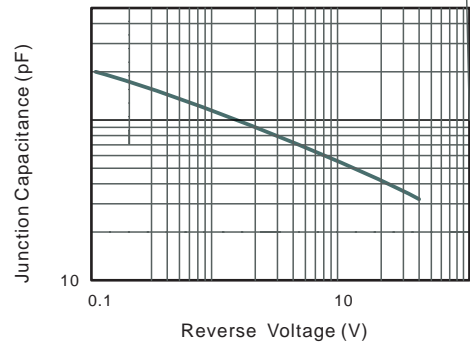

**Fig.5 Maximum Non-Repetitive Peak Forward Surge Current**

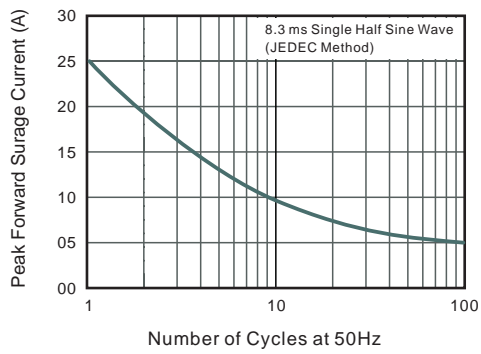

# B5817W THRU B5819W

## PACKAGE OUTLINE

Plastic surface mounted package; 2 leads

SOD-123

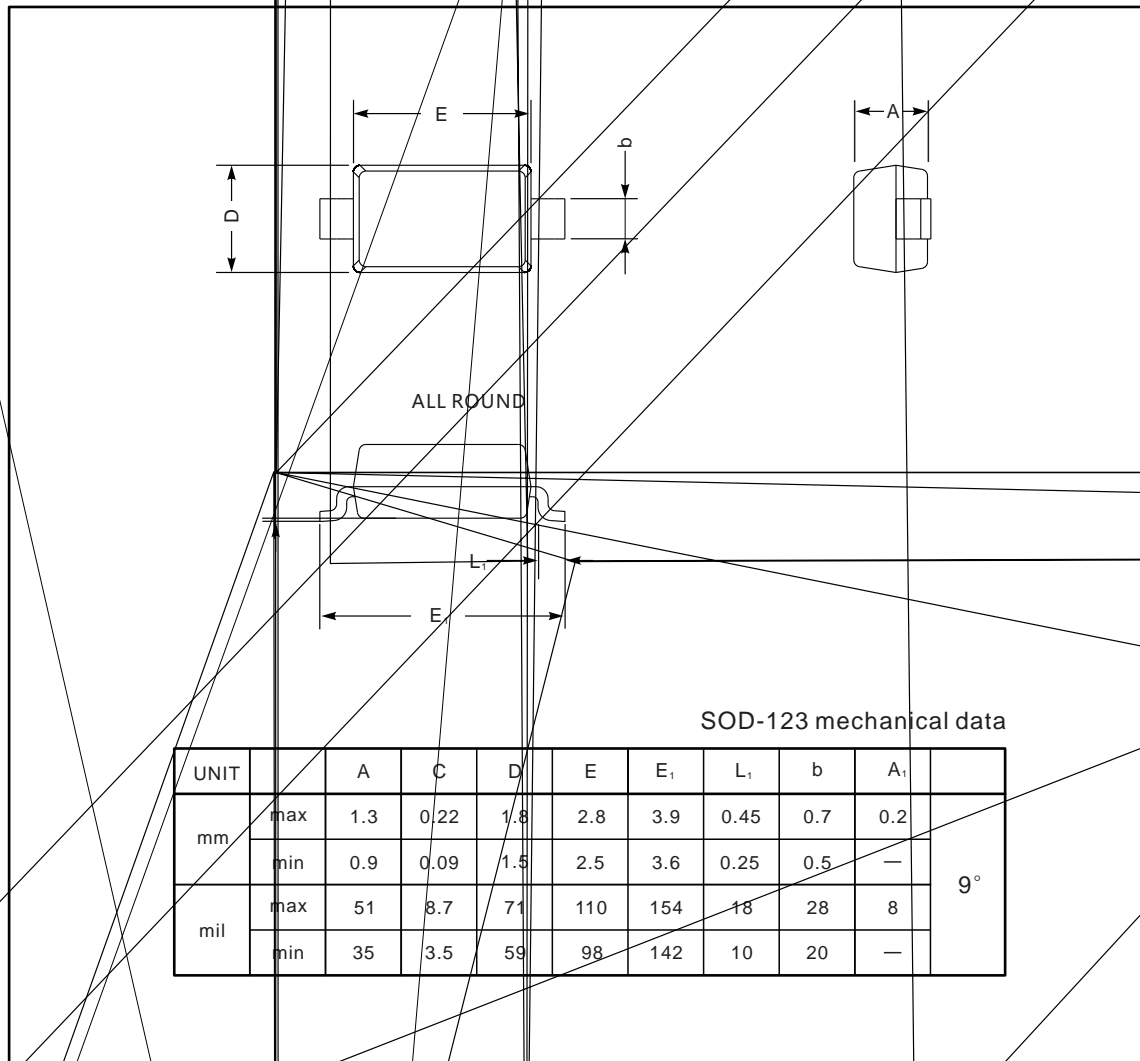

### The recommended mounting pad size

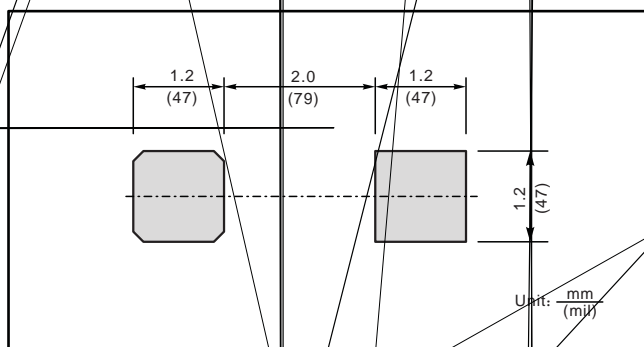

### Marking

Type number	Marking code
B5817W	
B5818W	
B5819W	