



# 深圳市弗瑞鑫电子有限公司

## 规格承认书

—  
\_\_\_\_\_  
\_\_\_\_\_

prepare	
check	
approve	



TRX电容一级代理商

深圳市弗瑞鑫电子有限公司

Add:深圳市宝安区西乡大道302号金源商务大厦B座3楼

Tel:0755-29563634

Fax:0755-27447020



 <b>TRX</b> 专注电容器廿年	<b>SMD Y</b> <b>SMD Y1 a.c. ceramic capacitors</b>			
	/Number		/Date	
	/Edition		/Page	



MD Y  
SMD ceramic capacitors

/Num

/Date

/Edi

/Page

1. /Product Name

T   M   Y1   101   K  
①   ②   ③   ④   ⑤

①				
②				
③				
④				
⑤				

2. /Product marking

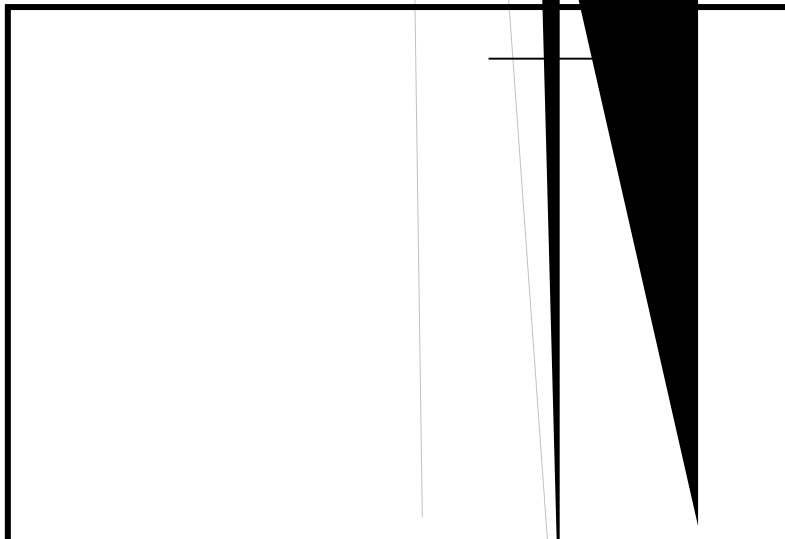
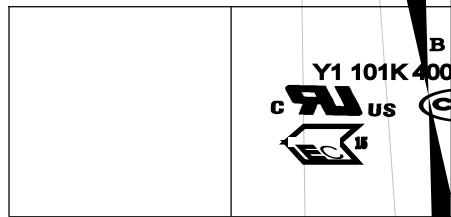



**4. /Certificates**

certificates			

**5. / Product structure**

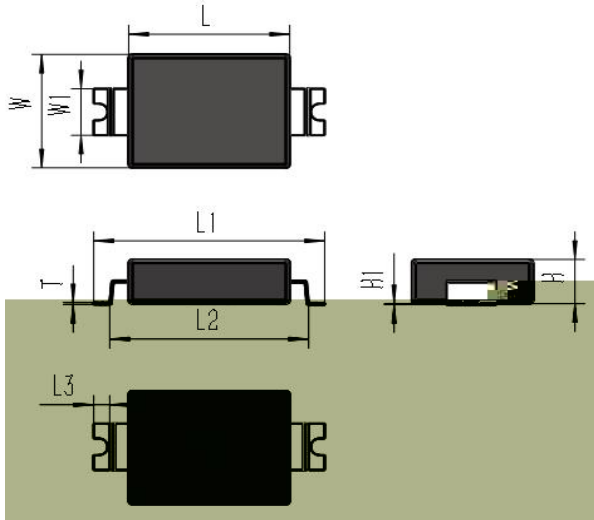

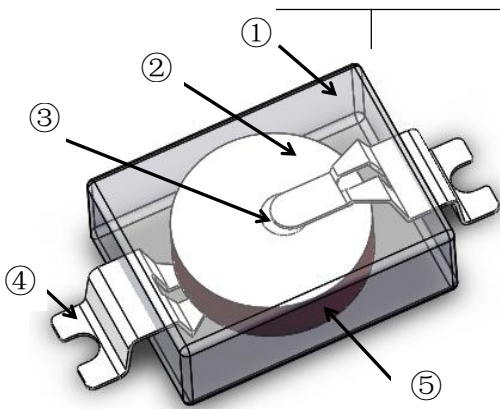
(4)		
(5)		



	<b>SMD Y</b> <b>SMD Y1 a.c. ceramic capacitors</b>		
	/Number		/Date
	/Edition		/Page

/

°  
°C

°

°

°

/

**7. / Performance and test methods**



 <b>CTR</b> 专注电容器廿年	<b>SMD Y</b>		
	<b>SMD Y1 a.c. ceramic capacitors</b>		
	<b>/Number</b>		<b>/Date</b>
<b>/Edition</b>		<b>/Page</b>	



**SMD Y**  
**SMD Y1 a.c. ceramic capacitors**



/Number

/Date

/Edition

/Page

**SMD Y**  
**SMD Y1 a.c. ceramic capacitors**



/Number

/Date

/Edition

/Page

		△	
		△	
		△	
		△	
		△	
		△	
		△	
		△	
		△	
		△	

**SMD Y**  
**SMD Y1 a.c. ceramic capacitors**





/Number

/Date

/Edition

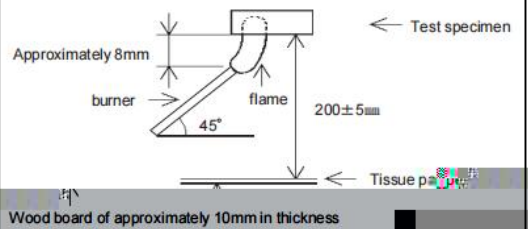
/Page



 <b>TRX</b> 专注电容器廿年	<b>SMD Y</b> <b>SMD Y1 a.c. ceramic capacitors</b>			
	/Number		/Date	
	/Edition		/Page	



	<b>SMD Y</b> <b>SMD Y1 a.c. ceramic capacitors</b>			
	/Number		/Date	
	/Edition		/Page	

**9. /Content of toxic and harmful substances control requirements**





**10. /Storage conditions**

(1)

(2)

/

/

(3)

(4)

 <b>TRX</b> 专注电容器廿年	<b>SMD Y</b> <b>SMD Y1 a.c. ceramic capacitors</b>			
	/Number		/Date	
	/Edition		/Page	

11.

/Prodn

r

11

' 4.7 879.1.82 0 TD[( R)]TJ 139.188 0 TD[(Q')]TJ 28.8791

 <b>TRX</b> 专注电容器廿年	<b>SMD Y</b> <b>SMD Y1 a.c. ceramic capacitors</b>		
	/Number		/Date
	/Edition		/Page

**/inner-packaging**

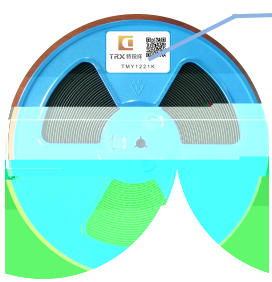

标签



料号

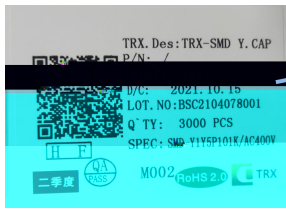

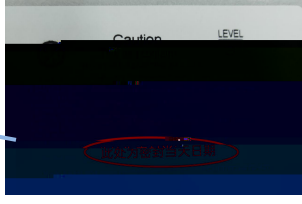

**/Outer-packaging**





图示 /



图示 /



图示 /



**/Package sketch:**



/



/





**Remark**



	<b>SMD Y</b> <b>SMD Y1 a.c. ceramic capacitors</b>		
	/Number		/Date
	/Edition		/Page

**12. /Application notes**

①

②

③

④

⑤

⑥