

TRX 特锐祥
专注电容器材料



SMD- 1
SMD 1 . .

/N

/D

/E

/P

/

I

/

II

TR

SMD- 1.CAP

C

R

T.C D

(: F

T.C						

	SMD- 1 SMD 1 . .		
	/N		/D
	/E		/P

 TRX 专注电容器廿年	SMD- 1 SMD 1 . .		
	/N		/D
	/E		/P

1. /P N

T G _1 102 K

		×

2. /P

	B Y1 102K 400V 



/N

SMD- 1
SMD 1 . .

	SMD- 1 SMD 1 . .		
	/N		/D
	/E		/P

/

/

7. /P



SMD- 1
SMD 1 . .

/N		/D	
/E		/P	

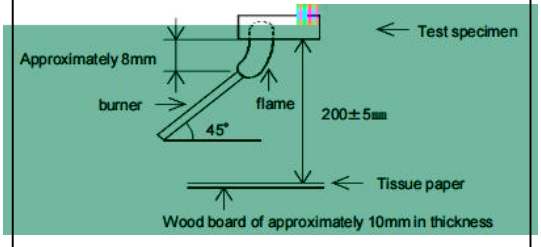

 TRX 专注电容器廿年	SMD- 1		
	SMD 1 . .		
	/N		/D
/E		/P	

			± ±
			± ±
			±
			± ±
			± ±
			±

8. /C

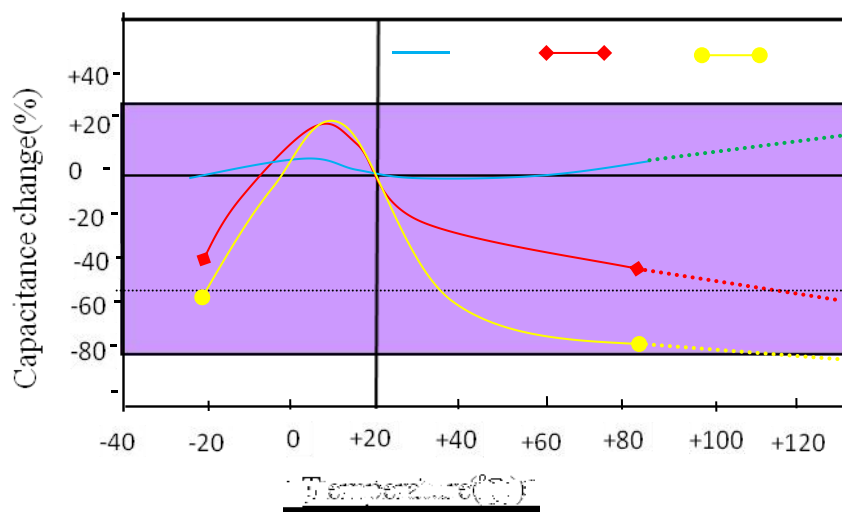

 TRX 专注电容器廿年	SMD- 1 SMD 1 . .		
	/N		/D
	/E		/P

9.

/C

R HS H.F.
REACH

10. /S

/
/

 TRX 专注电容器廿年	SMD- 1		
	SMD 1 . .		
	/N		/D
/E		/P	

11. /P
/

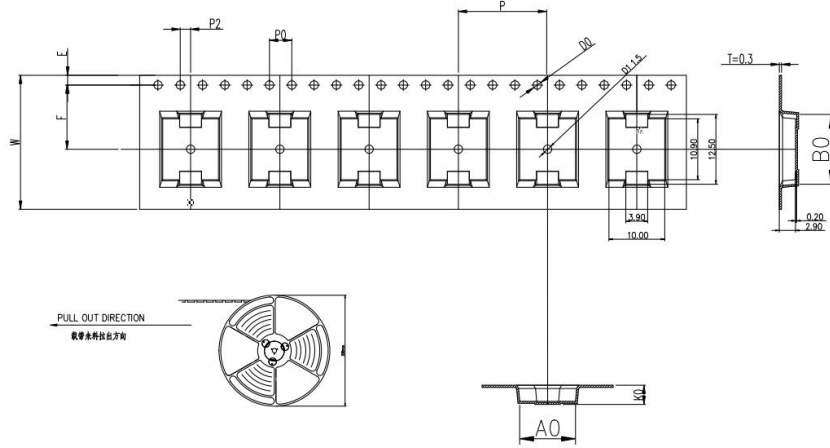

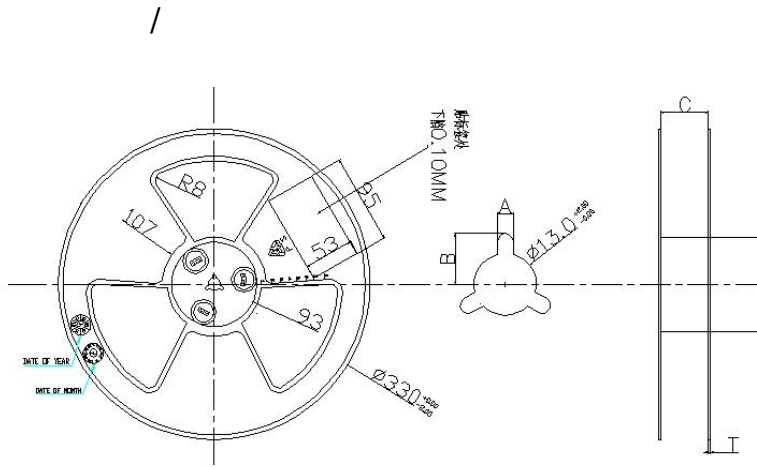

ITEM	W	A0	B0	K1	K0	P	F	E	D0	D1	P0	P2	T														
DIM	24.0	$^{+0.30}_{-0.30}$	10.0	$^{+0.10}_{-0.10}$	12.5	$^{+0.10}_{-0.10}$	3.45	$^{+0.10}_{-0.10}$	16.0	$^{+0.10}_{-0.10}$	11.50	$^{+0.10}_{-0.10}$	1.75	$^{+0.10}_{-0.10}$	10.00	$^{+0.10}_{-0.10}$	1.5	$^{+0.10}_{-0.00}$	1.5	$^{+0.10}_{-0.00}$	4.0	$^{+0.10}_{-0.10}$	2.0	$^{+0.10}_{-0.10}$	0.30	$^{+0.05}_{-0.05}$	
ALTERNATE																											

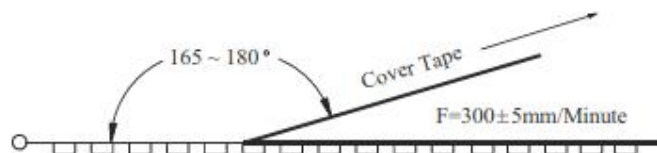

SPEC	A±0.3	B±0.5	C $^{+0.5}_{-0.0}$	D±0.5	T±0.2
24	2.3	10.75	24.4	Ø97	2.2

Item	Data	Remark
Cover tape adhesion	10 ~ 100g	Carrier tape and cover tape open angle 165 ~ 180° F=300± 5mm/minute



 TRX 专注电容器廿年	SMD- 1 SMD 1 . .		
	/N		/D
	/E		/P

/ -





TRX 特锐祥
TGY1102K







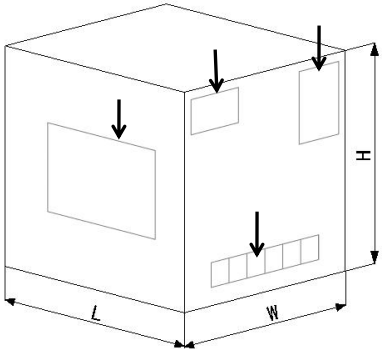

/O -





TRX 特锐祥
专注电容器







/
/
/

/P :









/
/

" "

R

