

, * % 7 0 R G X O H V

9 & (6 9
, & \$

\$ S S O L F D W L R Q V

g 0 R W R U ' U L Y H U V

g \$ & D Q G ' & V H U Y R G U L Y H D P S O L I L H U

g 8 3 6 8 Q L Q W H U U X S W L E O H 3 R Z H U 6 X S S O

) H D W X U H V

g / R Z V Z L W F K L Q J O R V V H V

g / R Z F Y V D Z W L W K S R V L V D W X H U W H F R S H I L F L H Q W

g , Q F O X G L Q J I D F R W H U M R D W W L H S D U D O O H O

g / R Z L Q G X F W D Q F H F D V H

g + L J K V K R U W F L U F X L W F D S D E L O L W \ X

g , V R O D W H G K H D W V L Q N X V L Q J ' % & W H F K

g 0 D [L P X P M X Q F W L R Q W H P S H U D W X U H

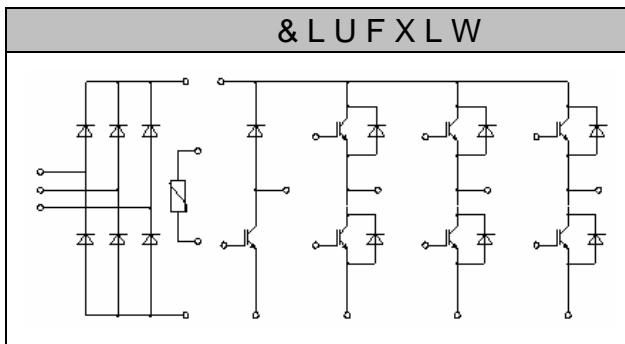

, * % 7 L Q Y H U W H U

\$ E V R O X W H 0 D [L P X P 5 D W L Q J V

3 D U D P H W H U	6 \ P E R O	& R Q G L W L R Q V	9 D O X H
& R O O H F W R U (P L W W H U 9 R O W D J H	9 - (9 & , P \$ 9 y M -		9
& R Q W L Q X R X V & R O O H F W R U & X U J H Q W	7 _F - 7 _{Y M P D [} - ,		\$
5 H S H W L W L Y H 3 H D N & R O O H F W R U	R ₆₀ & X J U H S Q W P V	,	\$
* D W H (P L W W H U 9 R O W D J H	' (6 7 _{Y M} - 9	"	9
7 R W D O 3 R Z H U ' L V V L S D W L R Q	W R W 7 _F - 3 7 _{Y M P D [} -		:



0 *

3

3

RoHS
COMPLIANT

, *%7 LQYHUWHU
&KDUDFWHULVWLF YDOXHV

3DUDPHWHU	6\PERO	&RQGLWLRQV	9DOXH			8QLW
			0LQ	7\	0D[
*DWH HPLWWHU 7KUHVKROG 9RQWDJH	9&(&	PS97 -				9
&ROOHFWRU (PLWWHU &XW RII&&XUJH	9&(&XUJH	9 9(9 7M -				P\$
&ROOHFWRU (PLWWHU 6DWXUDWLRQ 9ROWDJH	9&(VDW	, F \$.9 9 7M -				9
		, F \$.9 9 7M -				
		, F \$.9 9 7M -				
*DWH &KDUJH	.	4				X&
,QSXW &DSDFLWDQFH	LHV	9&(9 9				
5HYHUVH 7UDQVIHU &DSDFLWDQFH	QFH	1 0+] 7M - &				Q)
*DWH (PLWWHU OHDNDJH FXUUHQW	FXUUHQW	9&(9 .9 9 .7M -				Q\$
7XUQ RQ 'HOD\ 7LPH	G RQ	W				QV
5LVH 7LPH	U	W & \$				QV
7XUQ RII 'HOD\ 7LPH	G RII	9&(W 9				QV
)DOO 7LPH	I	9-(" 9				QV
(QHUJ\ 'LVVLSDWLRQ 'XULQJ 7XUQ RQ 7LPH	RQ	W 5.				P-
(QHUJ\ 'LVVLSDWLRQ 'XULQJ 7XUQ RII 7LPH	RII	W 5.				P-
7XUQ RQ 'HOD\ 7LPH	G RQ	W				QV
5LVH 7LPH	U	W & \$				QV
7XUQ RII 'HOD\ 7LPH	G RII	9&(W 9				QV
)DOO 7LPH	I	9-(" 9				QV
(QHUJ\ 'LVVLSDWLRQ 'XULQJ 7XUQ RQ 7LPH	RQ	W 5.				P-
(QHUJ\ 'LVVLSDWLRQ 'XULQJ 7XUQ RII 7LPH	RII	W 5.				P-
6& 'DWD	VF ,	7S" XV .9 9 7M - 9FF 9 9(0" 9				\$



0 *

3

3

RoHS
COMPLIANT

'LRGH LQYHUWHU
\$EVROXWH 0D[LPXP 5DWLQJV

3DUDPHWHU	6\PERO	&RQGLWLRQV	9DOXH
5HSHWLWLYH 3HDN 5HYHUVH 9ROWDJH			9
&RQWLQXRXV '&)RUZDUG &XUHQW			\$
5HSHWLWLYH 3HDN)RUZDUG &XUHQW			\$
,W YDOXH	W	9 ₅ W PV Y _M -	\$ V
		9 ₅ W PV Y _M -	

&KDUDFWHULVWLF YDOXHV

3DUDPHWHU	6\PERO	&RQGLWLRQV	9DOXH			8QLW
			0LQ	7\ \$	0D[
)RUZDUG 9ROWDJH)) \$ 7 _M -				9
) \$ 7 _M -				
) \$ 7 _M -				
5HFRYHUHG &KDUJH	UU) 4 \$				X&
3HDN 5HYHUVH 5HFRYHU\ &XUHQW		9 ₅ 9 GLGW \$' XV				\$
5HYHUVH 5HFRYHU\ (QHUJ\	UHF	7 _{YM} - (P-
5HFRYHUHG &KDUJH	UU) 4 \$				X&
3HDN 5HYHUVH 5HFRYHU\ &XUHQW		9 ₅ 9 GLGW \$' XV				\$
5HYHUVH 5HFRYHU\ (QHUJ\	UHF	7 _{YM} - (P-



0 *

3

3

RoHS
COMPLIANT

, *%7 EUDNH FKRSSHU
\$EVROXWH 0D[LPXP 5DWLQJV

3DUDPHWHU	6\PERO	&RQGLWLRQV	9DOXH
&ROOHFWRU (PLWWHU 9ROWDJH	9(9 & P\$9,7M -		9
&RQWLQXRXV &ROOHFWRU &XUJHQW	7F - 7MPD[- ,		\$
5HSHWLWLYH 3HDN &ROOHFWRU &XUJHQW	7F - 7MPD[- ,		\$
*DWH (PLWWHU 9ROWDJH	7YM - 9	"	9
7RWDO 3RZHU 'LVVLSDWLRQ	7F - 7MPD[-		:

&KDUDFWHULVWLF YDOXHV

3DUDPHWHU	6\PERO	&RQGLWLRQV	9DOXH			8QLW
			0LQ	7\S	0D[
*DWH HPLWWHU 7KUHVKROG 9ROWDJH	9(9 & P\$9,7M -					9
&ROOHFWRU (PLWWHU &XWRIL &XUJHQW	9(9 9 7M -					P\$
&ROOHFWRU (PLWWHU 6DWXUDWLRQ 9ROWDJH	9(VDW	,F \$.9 9 7M -				9
		,F \$.9 9 7M -				
		,F \$.9 9 7M -				
*DWH &KDUJH	.	4				X&
,QSW &DSDFLWDQFH	LHV	9(9 9				Q)
5HYHUVH 7UDQVIHU &DSDFLWDQFH	9(9 9	1 0+] YM - &				Q)
*DWH (PLWWHU OHDNDJH FXUJHQW	9(9 9 9 7M -					Q\$
7XUQ RQ 'HOD\ 7LPH	G RQ	W				QV
5LVH 7LPH	U	W & \$				QV
7XUQ RII 'HOD\ 7LPH	G RII	9(W 9				QV
)DOO 7LPH	I	9(" 9				QV
(QHUJ\ 'LVVLSDWLRQ 'XULQJ 7XUQ RQ 7LPH	9(9 9 9 7M -					P-
(QHUJ\ 'LVVLSDWLRQ 'XULQJ 7XUQ RII 7LPH	9(9 9 9 7M -					P-



0 *

3

3

RoHS
COMPLIANT

7XUQ RQ 'HOD\ 7LPH	G RQ	W				Q V
5LVH 7LPH	U	W & \$				Q V
7XUQ RII 'HOD\ 7LPH	G RII	9&(W 9				Q V
)DOO 7LPH	I	9.(" 9				Q V
(QHUJ\ 'LVVLSDWLRQ 'XULQJ 7XUQ RQ 7LPH		W.				P-
(QHUJ\ 'LVVLSDWLRQ 'XULQJ 7XUQ RII 7LPH		7				P-

6 & 'DWD

VF , 7s" XV.9 9 7M -
9FF 9 9



'LRGH 5HFWLILHU
\$EVROXWH 0D[LPXP 5DWLQJV

3DUDPHWHU	6\PERO	&RQGLWLRQV	9DOXH
5HSHWLWLYH 3HDN 5HYHUVH 9ROWDJH	9	- 9	9
\$YHUDJH RXWSXW &XUUHQW +] VLQH ZDYH) \$9	7F -	\$
0D[LPXP 506 &XUUHQW DW 5HFWLILHU 2XWSXW	506	, 7	\$
6XUJH)RUZDUG &XUUHQW)60	95 \$W ,PV 7 -	\$
,W YDOXH	W	, 95 \$W PV 7 -	\$V

&KDUDFWHULVWLF YDOXHV

3DUDPHWHU	6\PERO	&RQGLWLRQV	9DOXH			8QLW
			0LQ	7\ \$	0D[
'LRGH)RUZDUG 9ROWDJH)) \$ 79 -				9
5HYHUVH &XUUHQW	5	7M , - \$ 9				P \$

17 & 7KHUPLVWRU
&KDUDFWHULVWLF YDOXHV

3DUDPHWHU	6\PERO	&RQGLWLRQV	9DOXH			8QLW
			0LQ	7\ \$	0D[
5DWHG 5HVLVWDQFH	5					
'HYLDWLRQ RI 5	5	5 5 7				
3RZHU 'LVVLSDWLRQ	3					P :
% YDOXH	%	5 H[S >5% 7 . @				



0 *

3

3

RoHS
COMPLIANT



0 *

3

3

RoHS
COMPLIANT

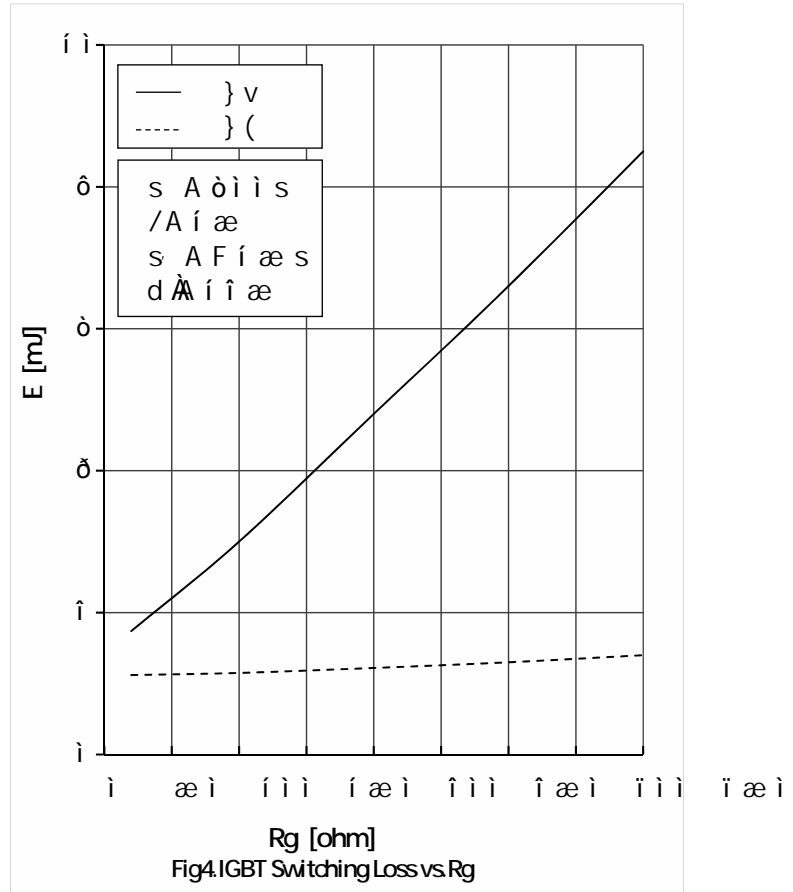
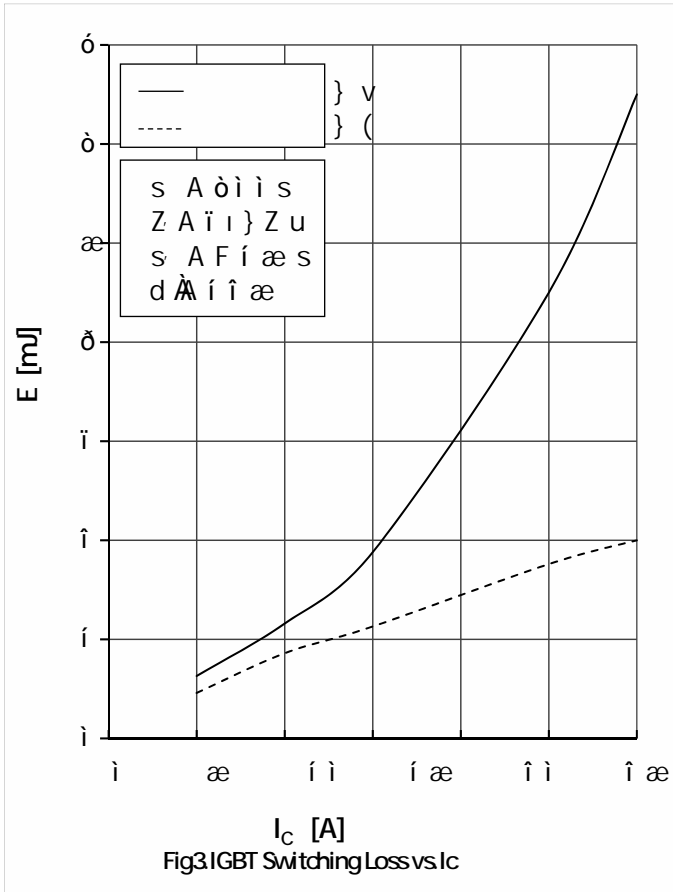
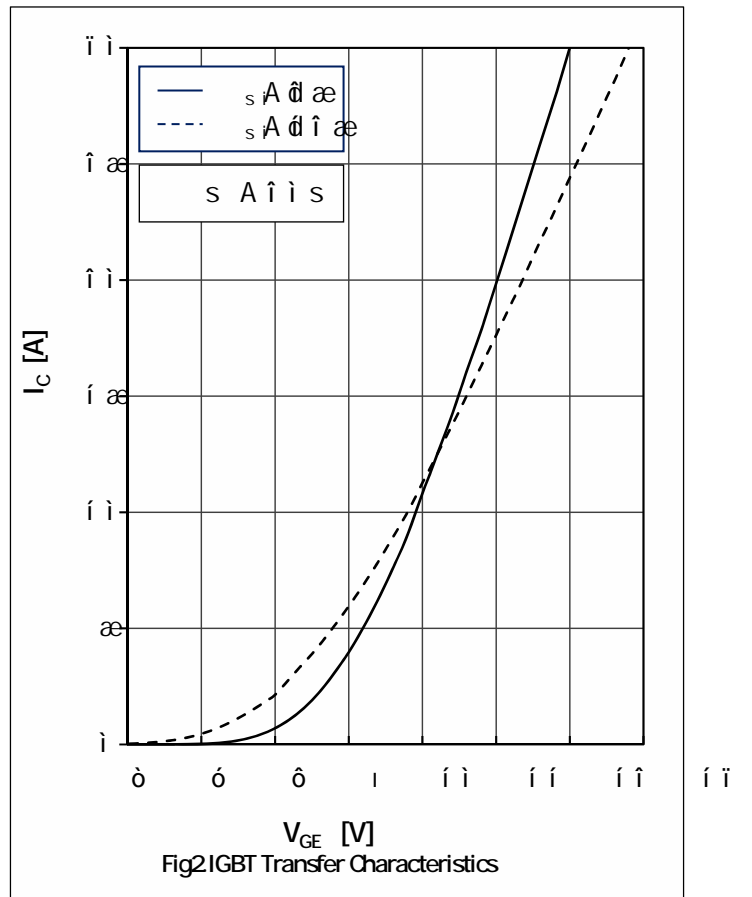
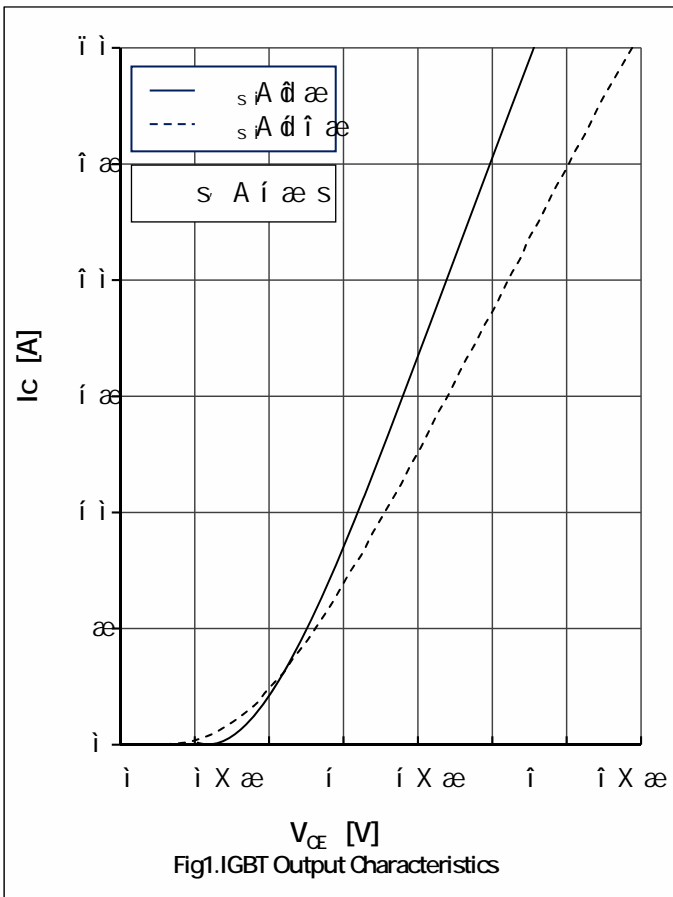



0 *

3

3

RoHS
COMPLIANT

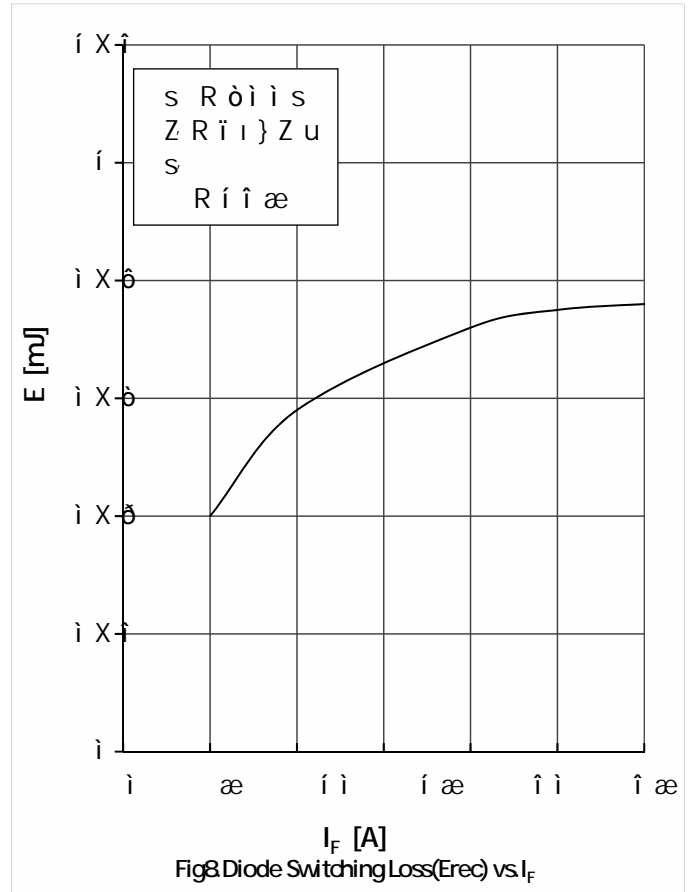
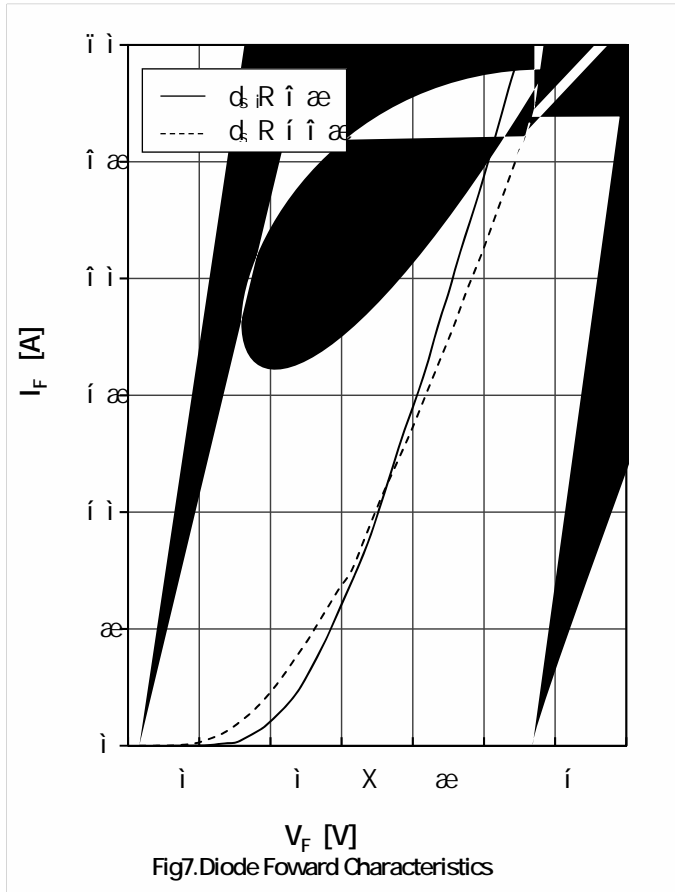
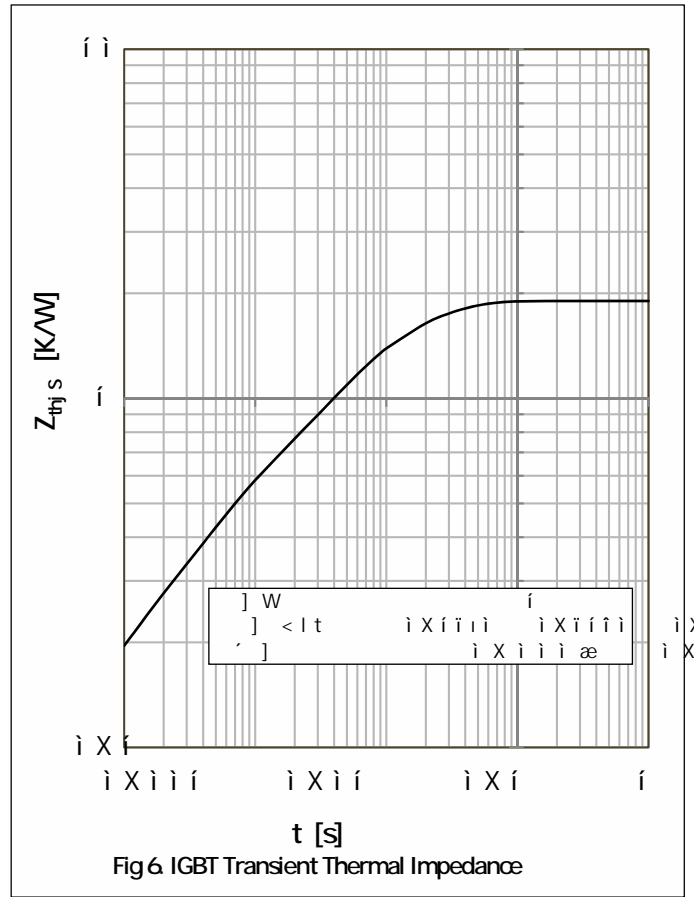
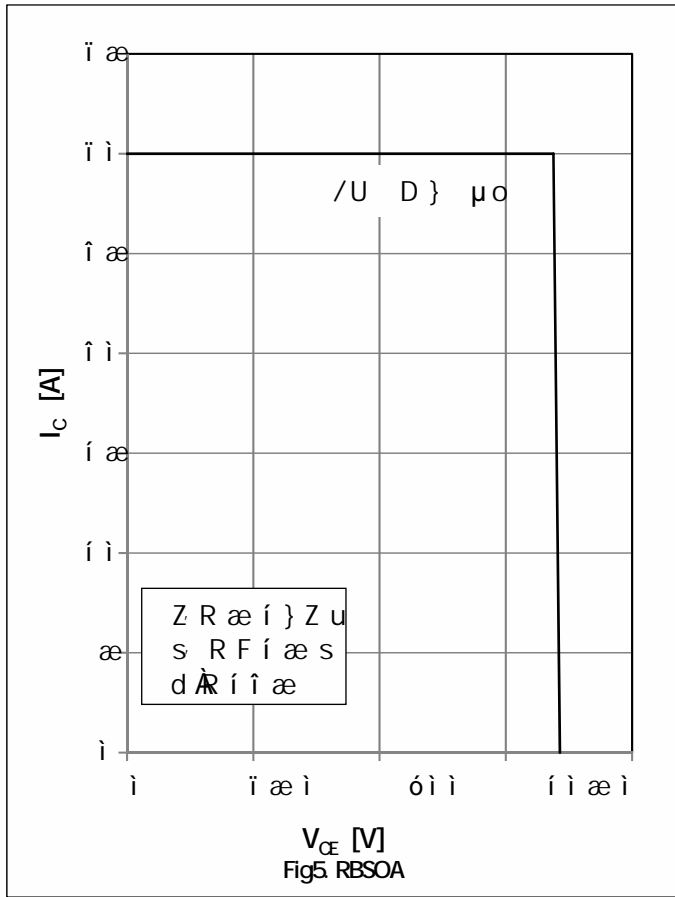



0 *

3

3

RoHS
COMPLIANT

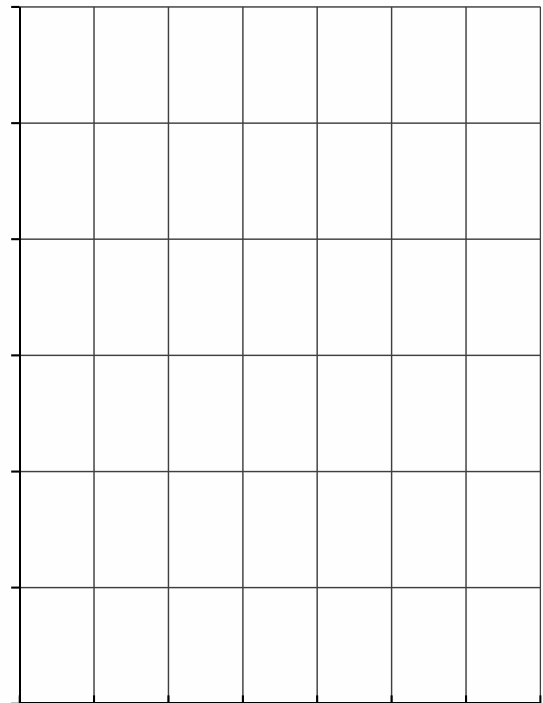
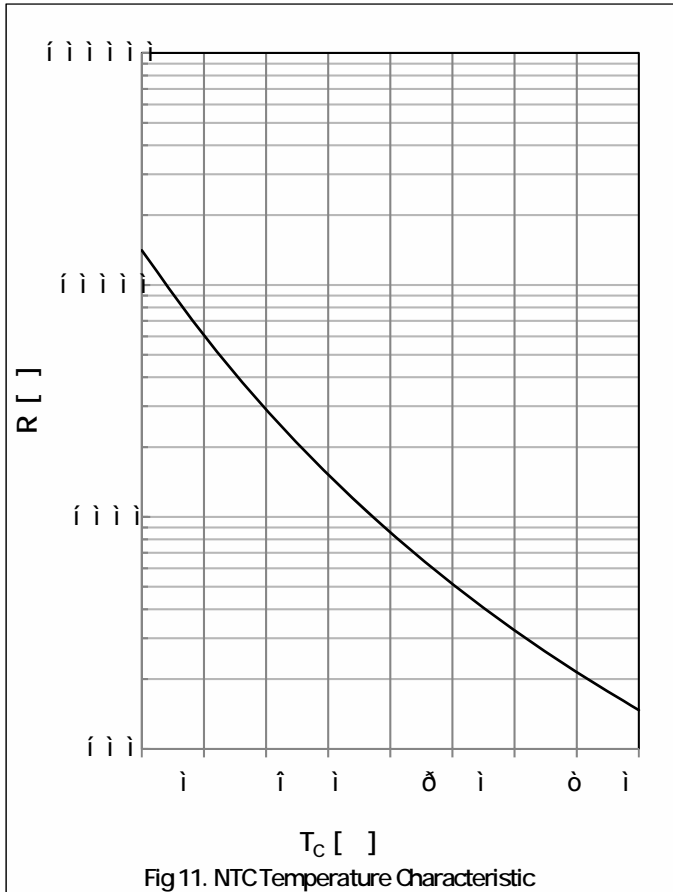
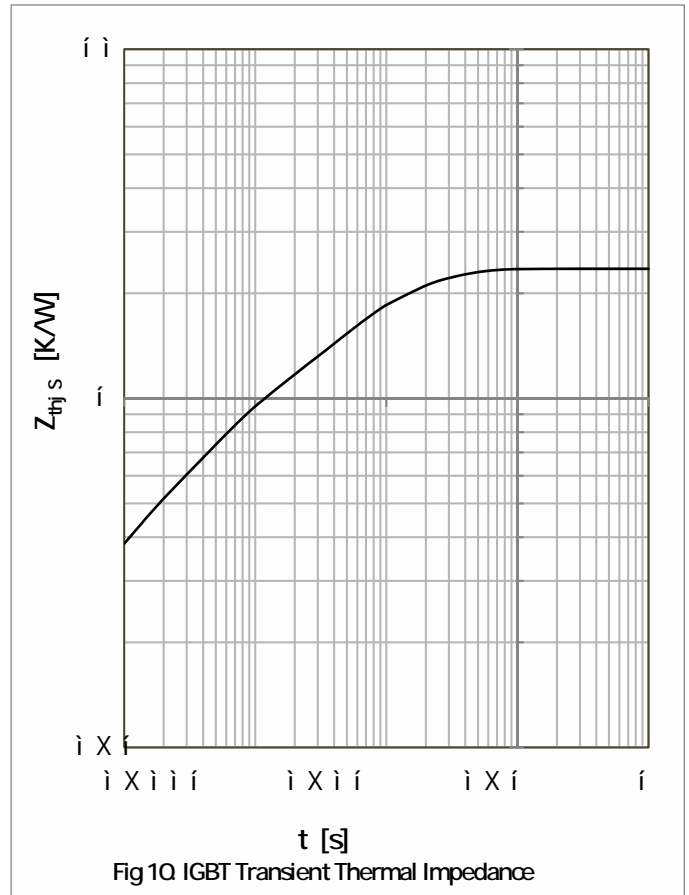
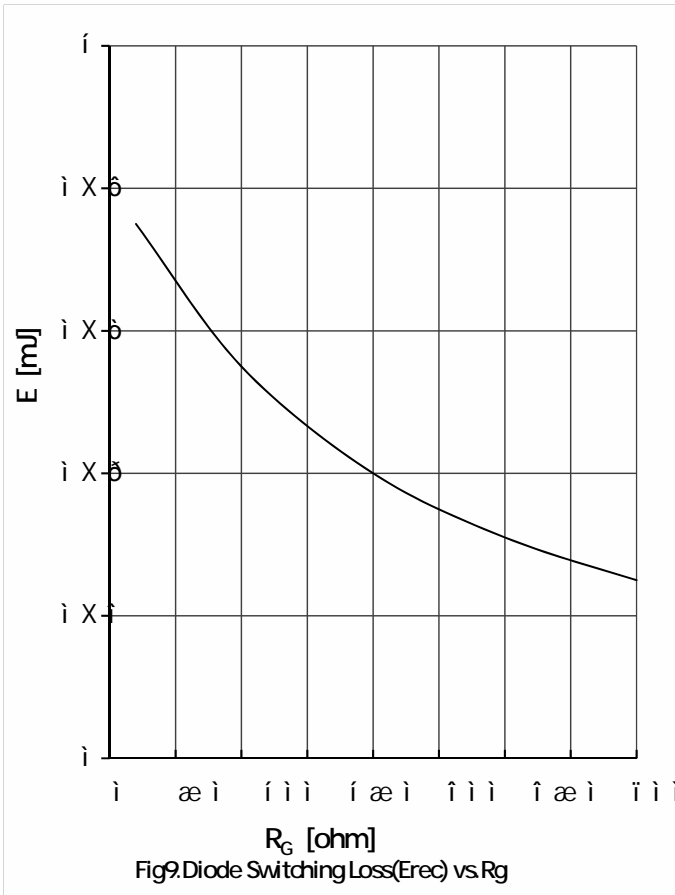



0 *

3

3

RoHS
COMPLIANT



0 *

3

3

RoHS
COMPLIANT

&LUFXLW 'LDJUDP

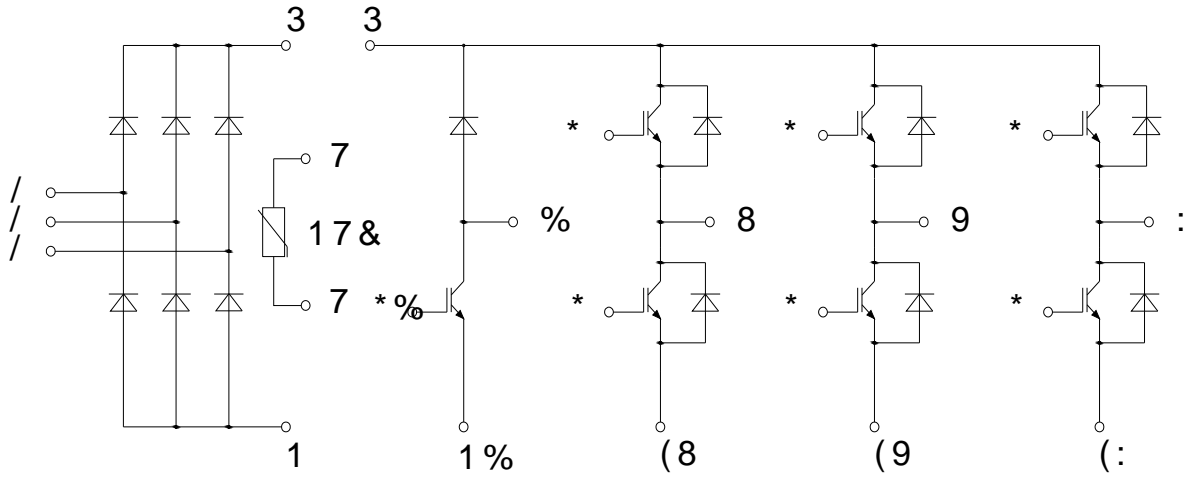

3DFNDJH 'LPHQVLRQV

